

# ROSS Model 42N Ribbon Blender Specifications and Dimensions

## STANDARD FEATURES:

- 1/2 through 1000 cubic foot capacity.
- Stainless steel type 304 wetted parts.
- Ribbon agitator for center discharge.
- Designed for atmospheric operation.
- 60 grit finish on interior and exterior stainless steel surfaces.
- One, two or three-piece blender cover with silicon gaskets.
- NEMA 12 safety limit switches prevent operation of the agitator when cover is raised.
- Stuffing boxes with easily disassembled split housing.
- TEFLON® braided packing.
- Manually operated knife gate discharge valve.
- Non-stainless steel external parts coated with a two-part acrylic urethane enamel coating.
- 230/460 volt, 60 Hz, three phase TEFC motor.
- Blender is mounted on supports providing a discharge clearance of 36".
- Suitable for product densities up to 64 pounds per cubic foot.

## OPTIONAL FEATURES:

- Wetted parts fabricated from stainless steel 316, abrasive-resistant carbon steel and other special alloys.
- Paddle or ribbon/paddle agitator.
- Vacuum or internal pressure capability.
- Sanitary finish and construction.
- Cover openings as required.
- Flush plug, spherical disc, or flush ball valve.
- Higher horsepower and design options for handling higher density materials.
- Explosion-proof or washdown motor.
- Control options include variable frequency drives, motor starters and operator stations.
- Spray nozzles for liquid introduction.
- Lumpbreakers for solids or agglomerates size reduction.
- Dimpled or baffled jacket for heating or cooling.
- Thermocouple and temperature readout.
- Special gasket materials such as Viton are available.
- Lantern rings for stuffing boxes.



Charles Ross & Son Company

710 Old Willets Path  
Hauppauge, NY 11788  
USA

631-234-0500 / 800-243-ROSS(7677)  
sales@mixers.com  
mixers.com

# ROSS Model 42N Ribbon Blender Specifications and Dimensions

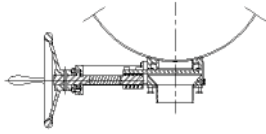

Standard Knife Gate Valve - dust-tight design.

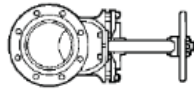

Optional Knife Gate Valve - liquid-tight design.

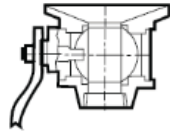

Optional Ball Valve - for vacuum/pressure operation and liquid-solid blending.

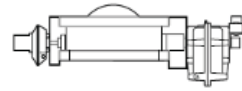

Optional Spherical Valve - pneumatically operated, this design minimizes dead space and provides a large opening.

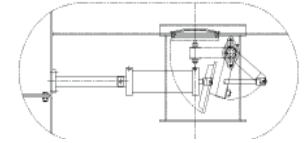

Optional Flush Plug Valve - eliminates dead spots in the blender trough; choice of manual or pneumatic design.

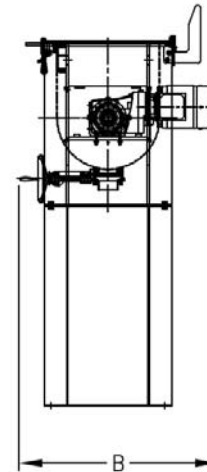
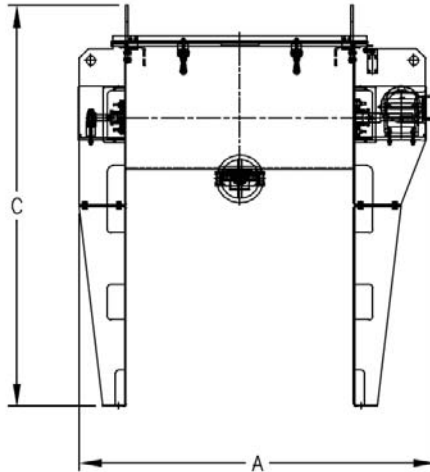

Model Number	Working Capacity		Full Capacity		Motor HP	Agitator RPM	Trough Size (inches)			Overall Dimensions (inches)			Shipping Weight (lbs)
	cu.ft.	gal	cu.ft.	gal			Width	Length	Depth	A	B	C	
42N-1/2	1/2	3 1/2	0.65	5	1/2	131	9	16	11	39	23	50	680
42N-1	1	7	1.3	9	3/4	99	12	20	14	43	26	53	700
42N-5	5	37	7	52	3	66	17	38	21	67	34	68	1000
42N-10	10	74	13	94	5	56	21	48	25	89	39	72	1600
42N-18	18	134	22	165	7 1/2	47	24	60	29	95	42	79	2650
42N-25	25	187	30	224	10	43	29	60	33	95	46	81	3000
42N-36	36	269	41	307	15	40	30	78	34	115	49	92	3400
42N-52	52	388	56	424	20	37	34	84	38	122	52	92	4500
42N-62.5	62.5	465	72	540	40	32	36	96	40	144	66	97	5000
42N-71	71	530	80	598	40	30	38	96	42	149	66	99	5500
42N-80	80	598	90	673	50	30	38	108	42	158	66	99	6000
42N-100	100	748	110	825	50	28	40	120	44	177	72	101	7000
42N-120	120	897	132	988	60	25	44	120	48	179	72	104	8000
42N-155	155	1159	168	1263	Per Application	23	50	120	54	185	78	112	12500
42N-180	180	1345	195	1459		20	54	120	58	189	85	120	13200
42N-215	215	1610	235	1756		20	54	144	58	193	85	125	14000
42N-270	270	2017	300	2241		19	54	144	66	195	104	129	17000
42N-325	325	2427	355	2651		15	72	144	72	201	123	132	22000
42N-385	385	2876	425	3175		15	72	144	78	207	130	137	26000
42N-515	515	3847	565	4220		15	72	197	78	260	130	137	30000
42N-600	600	4488	680	5087		13	84	158	93	225	139	121	N/A
42N-800	800	5984	900	6732		12	93	170	103	238	158	133	N/A
42N-1000	1000	7481	1120	8378		11	97	177	111	256	169	142	N/A